

Cabinetry Section

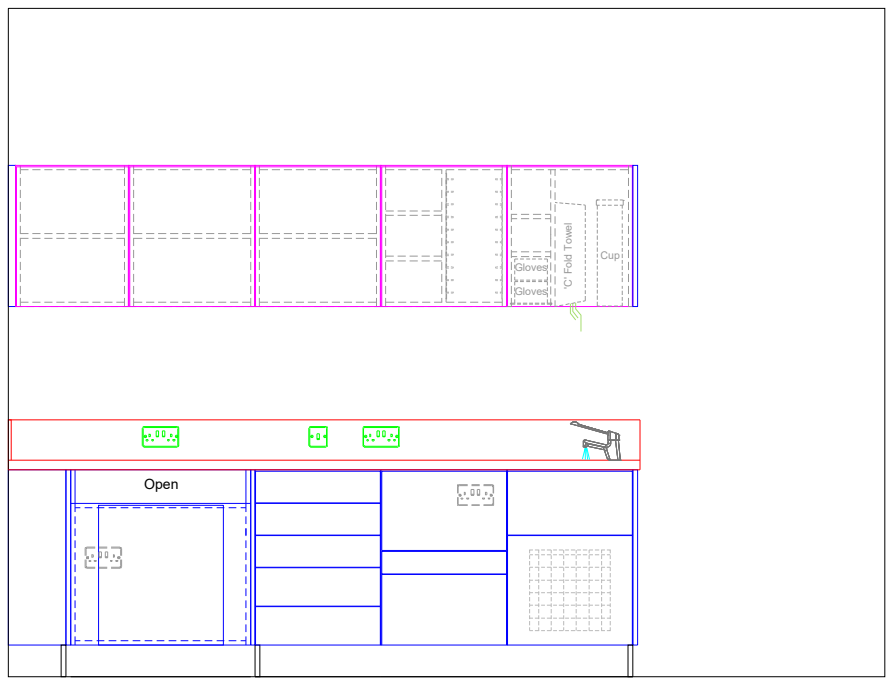

- Equipment Notes**
- Belmont Compass
 - Belmont touch x-ray
 - Microscope (BY OTHERS)

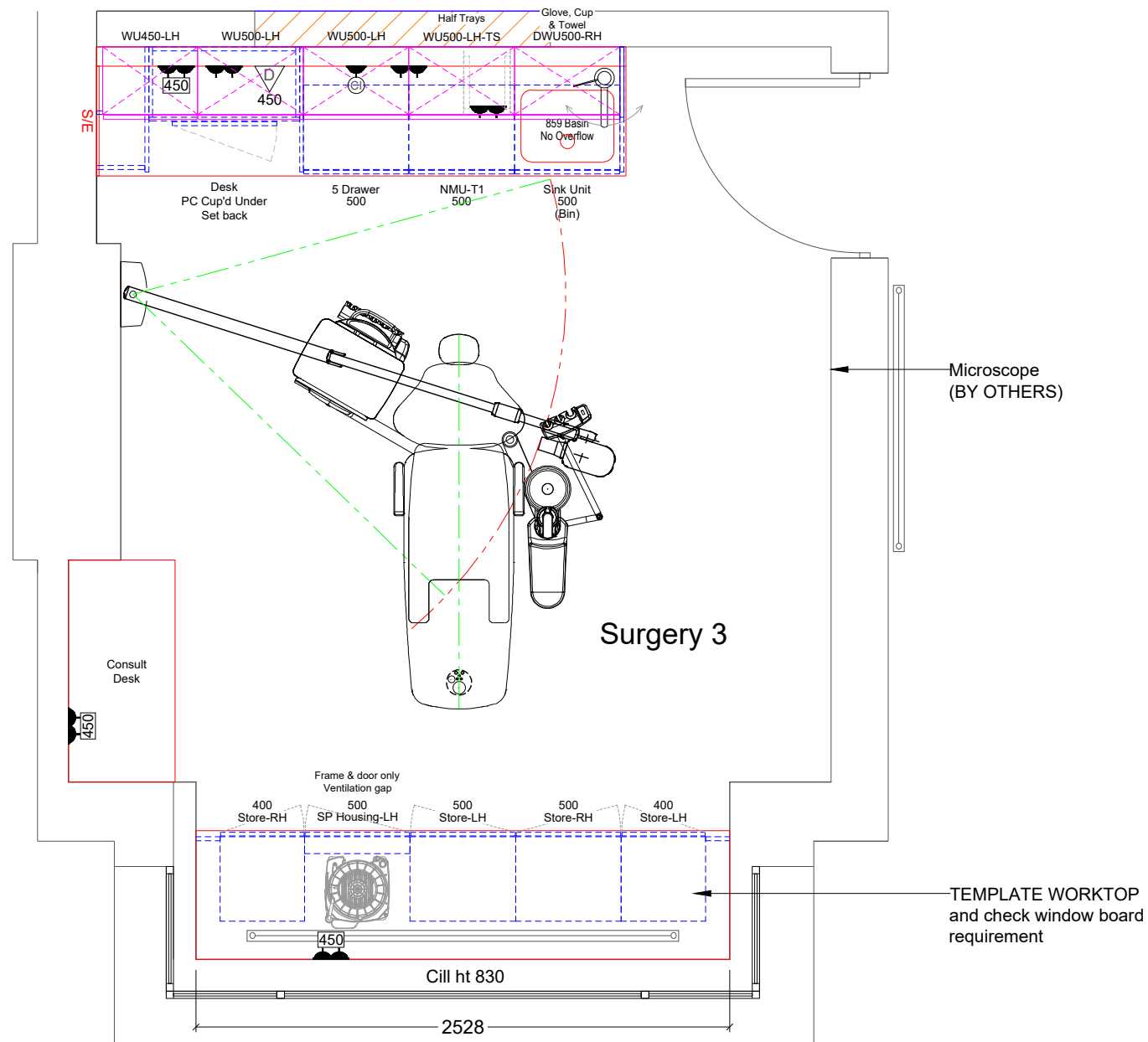

NOTE:
Handles are removed for clarity and will be fitted unless handle free has been quoted

IMPORTANT NOTES

WORK TO FIGURED DIMENSIONS ONLY.
CHECK DIMENSIONS ON SITE BEFORE COMMENCING WORK.

ANY DISCREPANCIES SHOULD BE REPORTED BACK TO OUR OFFICE.

X-RAY LOCATION / RPA

Any indications given in respect of radiation protection, the siting of x-ray equipment and / or x-ray controls is for guidance purposes only. It is for your appointed RPA to review the environment in which the x-ray machine is to operate and to ensure your compliance under IRR99. This drawing should not be used as the basis for any design, construction work or the provisioning of services involving x-ray equipment without the approval of your RPA.

THIS DESIGN SHOULD BE APPROVED BY YOUR INFECTION CONTROL ADVISOR PRIOR TO COMMENCEMENT OF WORKS.



Park Farm Lane, Nuthampstead
Herts SG8 8LZ

Tel: 01763 849990
Email: info@angliandental.co.uk

CLIENT: HIRSCHOWITZ

LOCATION: EDGE DENTAL CARE
150 BROADFIELDS AVENUE,
EDGWARE, MIDDLESEX
HA8 8SS

JOB: FIT-OUT

ROOM: SURGERY 3

JOB REF: 041929

DRAWING No: D40157

Rev

D

DRAWING SCALE: 1:30

A3

	NAME	DATE
DRAWN BY:	GH	25/07/2022
CHECKED BY:	*	*

DO NOT SCALE FROM THIS DRAWING.

ALL DIMENSIONS ARE IN mm UNLESS OTHERWISE STATED

THIS DRAWING IS AN ANGLIAN DENTAL ENGINEERING A3 ORIGINAL

COPYRIGHT ANGLIAN DENTAL ENGINEERING ©2022

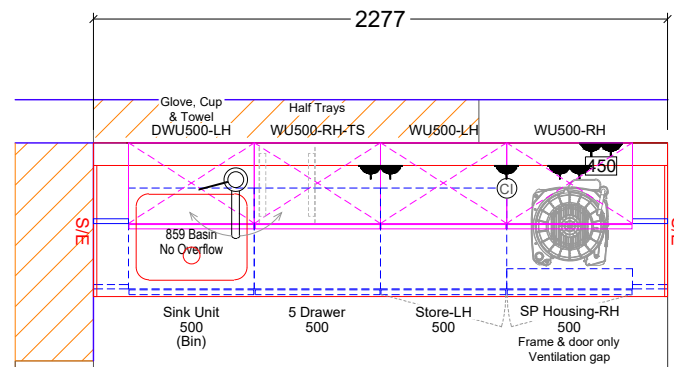
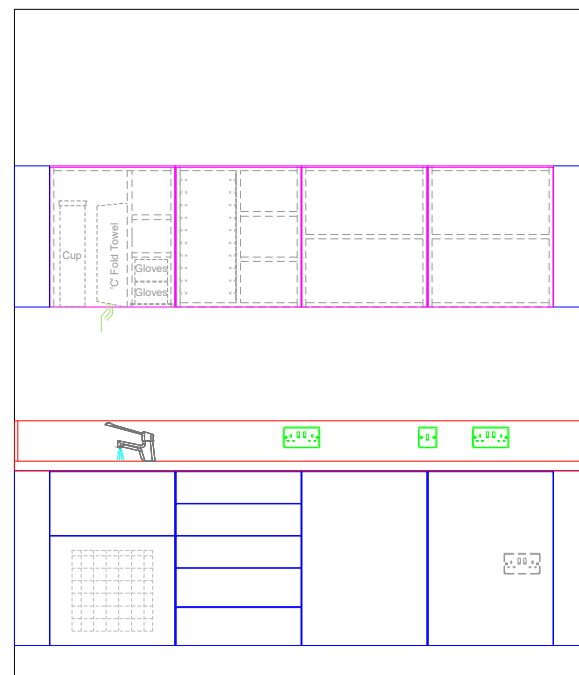
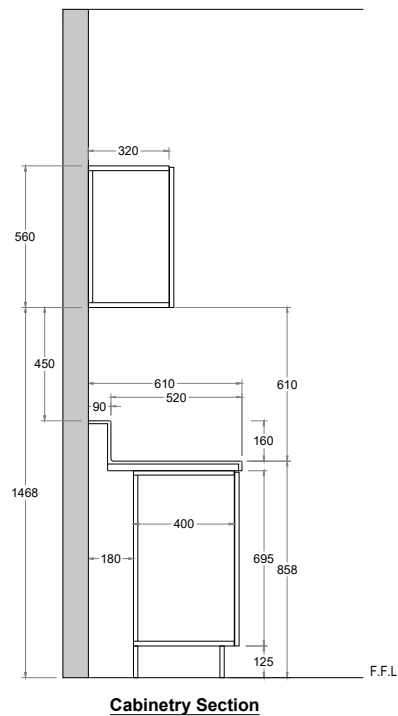

- Equipment Notes**
- Belmont Compass
 - Provision for Future x-ray

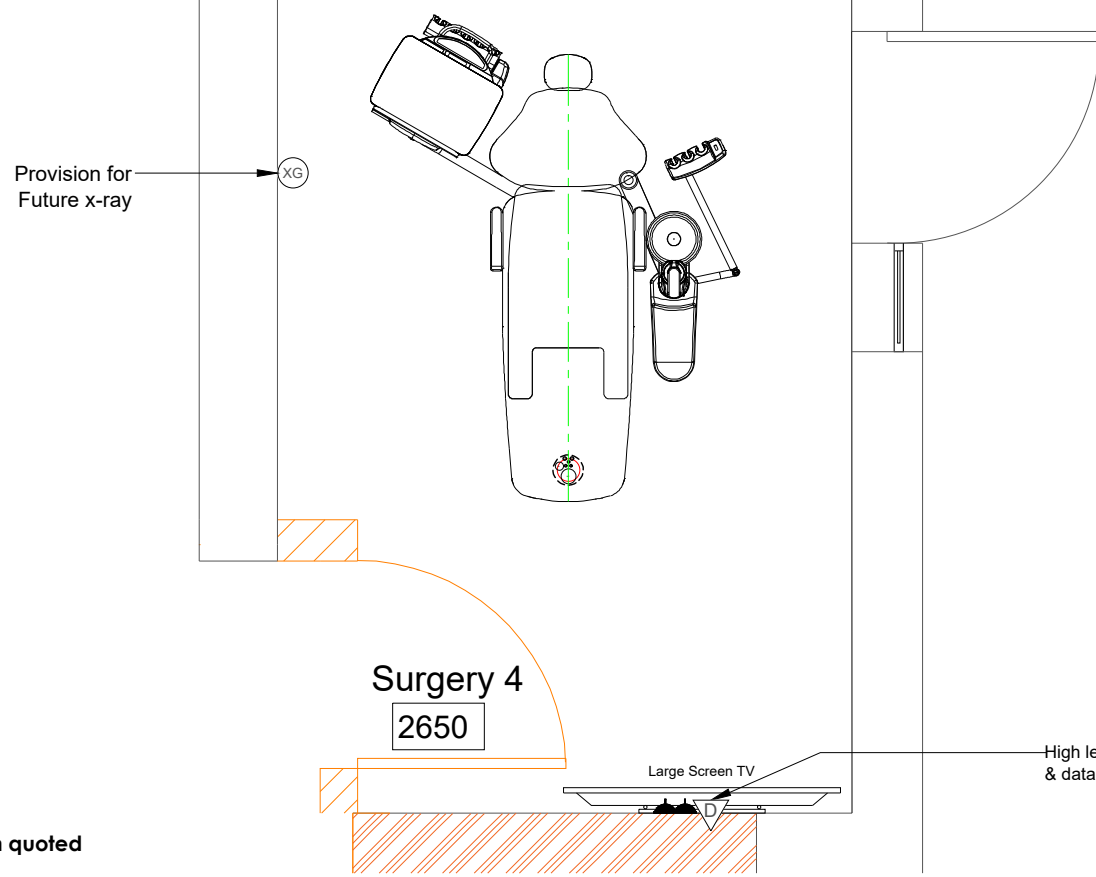

NOTE:
Handles are removed for clarity and will be fitted unless handle free has been quoted

IMPORTANT NOTES
WORK TO FIGURED DIMENSIONS ONLY.
CHECK DIMENSIONS ON SITE BEFORE COMMENCING WORK.
ANY DISCREPANCIES SHOULD BE REPORTED BACK TO OUR OFFICE.

X-RAY LOCATION / RPA
Any indications given in respect of radiation protection, the siting of x-ray equipment and / or x-ray controls is for guidance purposes only. It is for your appointed RPA to review the environment in which the x-ray machine is to operate and to ensure your compliance under IRR99. This drawing should not be used as the basis for any design, construction work or the provisioning of services involving x-ray equipment without the approval of your RPA.

THIS DESIGN SHOULD BE APPROVED BY YOUR INFECTION CONTROL ADVISOR PRIOR TO COMMENCEMENT OF WORKS.



Park Farm Lane, Nuthampstead
Herts SG8 8LZ

Tel: 01763 849990
Email: info@angliandental.co.uk

CLIENT: HIRSCHOWITZ

LOCATION: EDGE DENTAL CARE
150 BROADFIELDS AVENUE,
EDGWARE, MIDDLESEX
HA8 8SS

JOB: FIT-OUT

ROOM: SURGERY 4

JOB REF: 041929

DRAWING No: D40157	Rev D
---------------------------	-----------------

DRAWING SCALE: 1:20	A3
----------------------------	-----------

	NAME	DATE
DRAWN BY:	GH	25/07/2022
CHECKED BY:	*	*

DO NOT SCALE FROM THIS DRAWING.

ALL DIMENSIONS ARE IN mm UNLESS OTHERWISE STATED

THIS DRAWING IS AN ANGLIAN DENTAL ENGINEERING A3 ORIGINAL
COPYRIGHT ANGLIAN DENTAL ENGINEERING ©2022

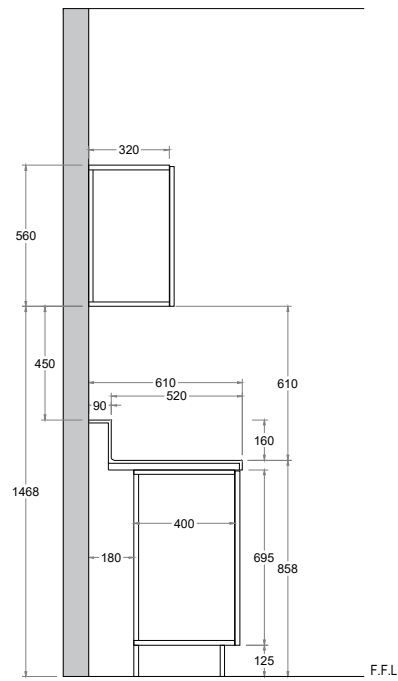

Cabinetry Section

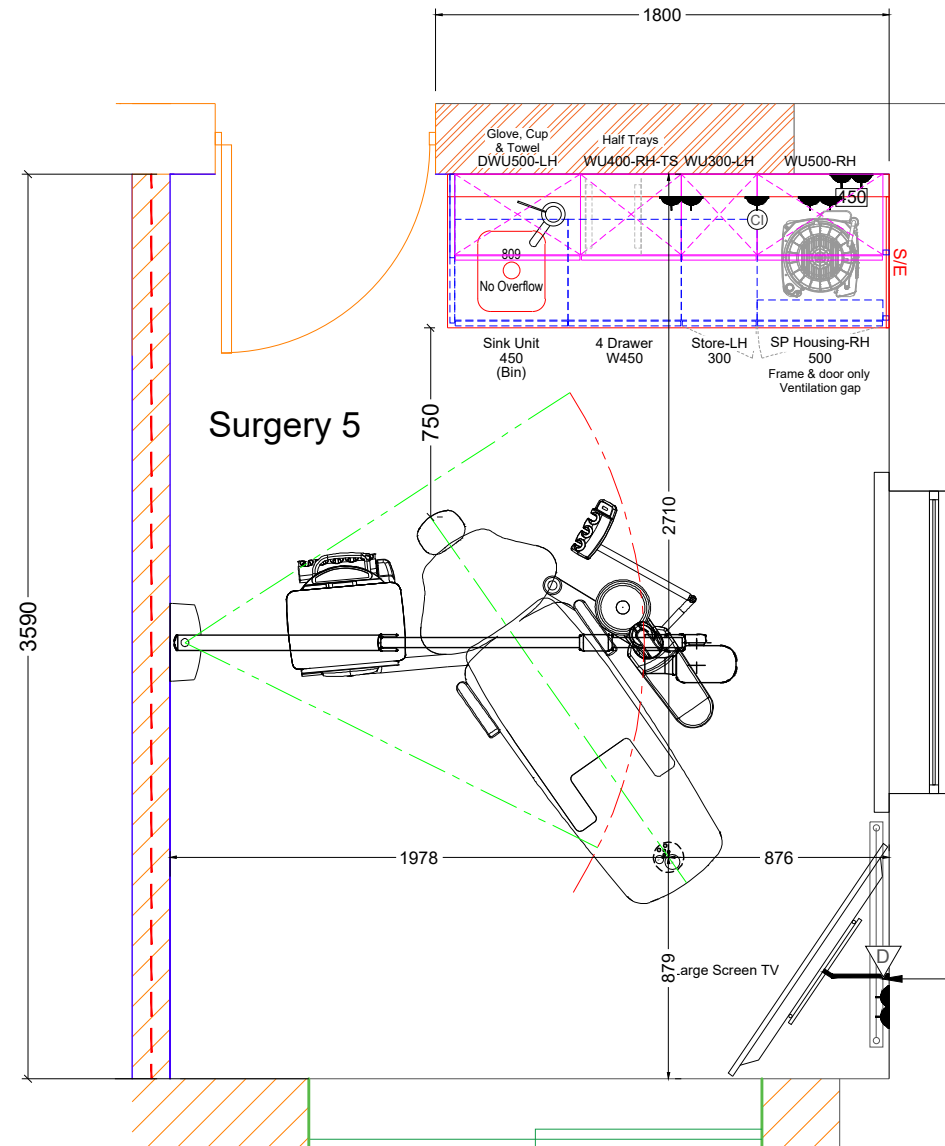
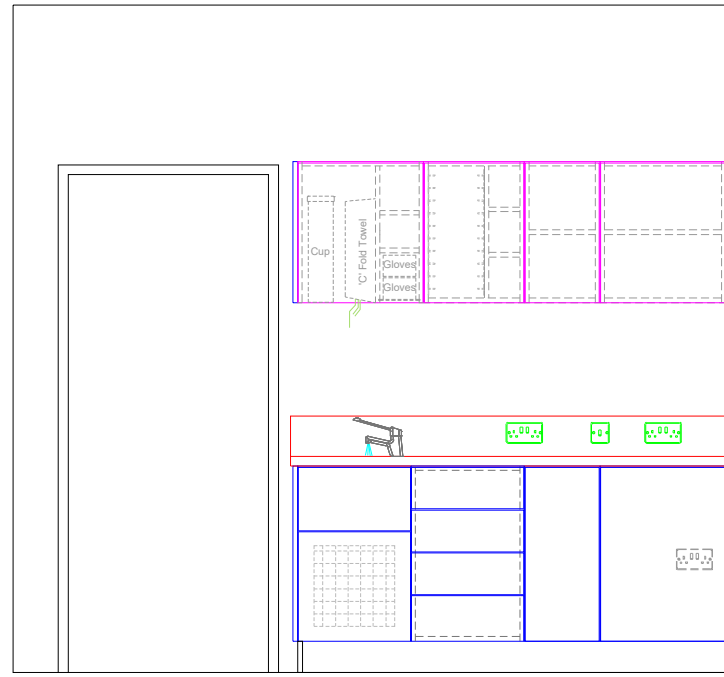

- Equipment Notes**
- Belmont Compass
 - Belmont Touch x-ray

IMPORTANT NOTES
 WORK TO FIGURED DIMENSIONS ONLY.
 CHECK DIMENSIONS ON SITE BEFORE COMMENCING WORK.
ANY DISCREPANCIES SHOULD BE REPORTED BACK TO OUR OFFICE.

X-RAY LOCATION / RPA
 Any indications given in respect of radiation protection, the siting of x-ray equipment and / or x-ray controls is for guidance purposes only. It is for your appointed RPA to review the environment in which the x-ray machine is to operate and to ensure your compliance under IRR99. This drawing should not be used as the basis for any design, construction work or the provisioning of services involving x-ray equipment without the approval of your RPA.

THIS DESIGN SHOULD BE APPROVED BY YOUR INFECTION CONTROL ADVISOR PRIOR TO COMMENCEMENT OF WORKS.



Park Farm Lane, Nuthampstead
 Herts SG8 8LZ

Tel: 01763 849990
 Email: info@angliandental.co.uk

CLIENT: HIRSCHOWITZ

LOCATION: EDGE DENTAL CARE
 150 BROADFIELDS AVENUE,
 EDGWARE, MIDDLESEX
 HA8 8SS

JOB: FIT-OUT

ROOM: SURGERY 5

JOB REF: 041929

DRAWING No: D40157	Rev D
---------------------------	------------------------

DRAWING SCALE: 1:30	A3
----------------------------	-----------

	NAME	DATE
DRAWN BY:	GH	25/07/2022
CHECKED BY:	*	*

DO NOT SCALE FROM THIS DRAWING.

ALL DIMENSIONS ARE IN mm UNLESS OTHERWISE STATED

THIS DRAWING IS AN ANGLIAN DENTAL ENGINEERING A3 ORIGINAL

COPYRIGHT ANGLIAN DENTAL ENGINEERING ©2022

NOTE:
 Handles are removed for clarity and will be fitted unless handle free has been quoted

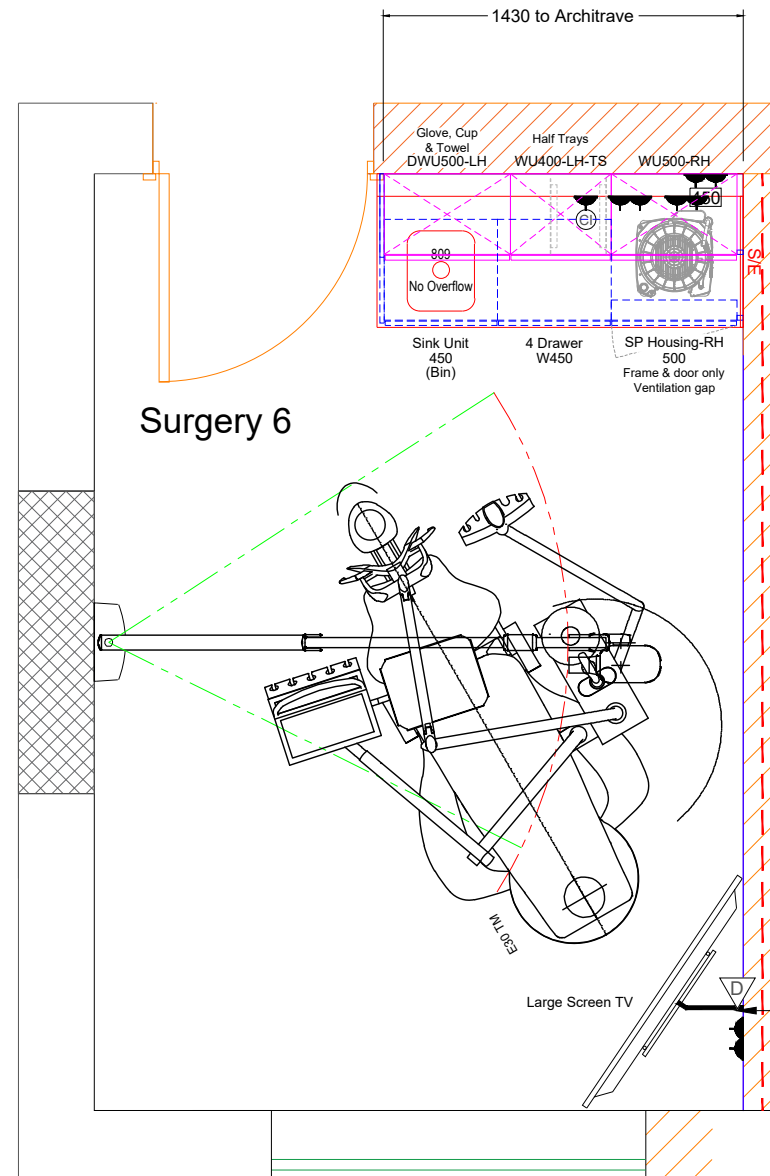
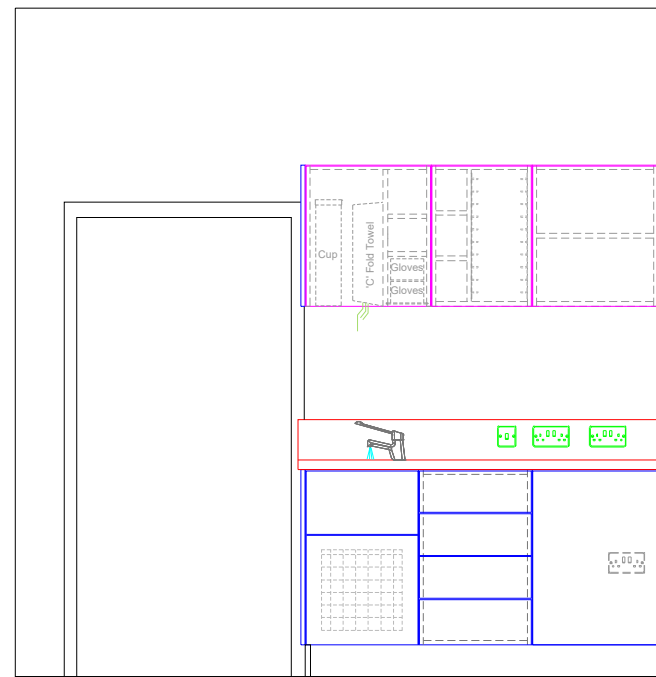
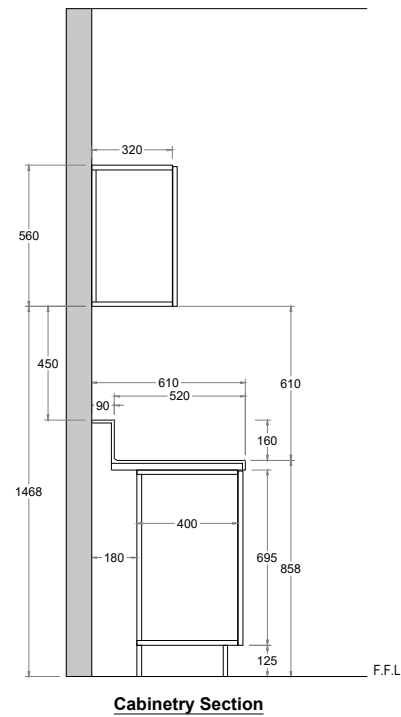

Equipment Notes

- Kavo E30TM
- Belmont 097 x-ray relocated from old Surgery 1

NOTE:
Handles are removed for clarity and will be fitted unless handle free has been quoted

IMPORTANT NOTES

WORK TO FIGURED DIMENSIONS ONLY.
CHECK DIMENSIONS ON SITE BEFORE COMMENCING WORK.
ANY DISCREPANCIES SHOULD BE REPORTED BACK TO OUR OFFICE.

X-RAY LOCATION / RPA

Any indications given in respect of radiation protection, the siting of x-ray equipment and / or x-ray controls is for guidance purposes only. It is for your appointed RPA to review the environment in which the x-ray machine is to operate and to ensure your compliance under IRR99. This drawing should not be used as the basis for any design, construction work or the provisioning of services involving x-ray equipment without the approval of your RPA.

THIS DESIGN SHOULD BE APPROVED BY YOUR INFECTION CONTROL ADVISOR PRIOR TO COMMENCEMENT OF WORKS.



Park Farm Lane, Nuthampstead
Herts SG8 8LZ

Tel: 01763 849990
Email: info@angliandental.co.uk

CLIENT: HIRSCHOWITZ

LOCATION: EDGE DENTAL CARE
150 BROADFIELDS AVENUE,
EDGWARE, MIDDLESEX
HA8 8SS

JOB: FIT-OUT

ROOM: SURGERY 6

JOB REF: 041929

DRAWING No:	Rev
D40157	D

DRAWING SCALE:	A3
1:30	

	NAME	DATE
DRAWN BY:	GH	25/07/2022
CHECKED BY:	*	*

DO NOT SCALE FROM THIS DRAWING.

ALL DIMENSIONS ARE IN mm UNLESS OTHERWISE STATED

THIS DRAWING IS AN ANGLIAN DENTAL ENGINEERING A3 ORIGINAL

COPYRIGHT ANGLIAN DENTAL ENGINEERING ©2022

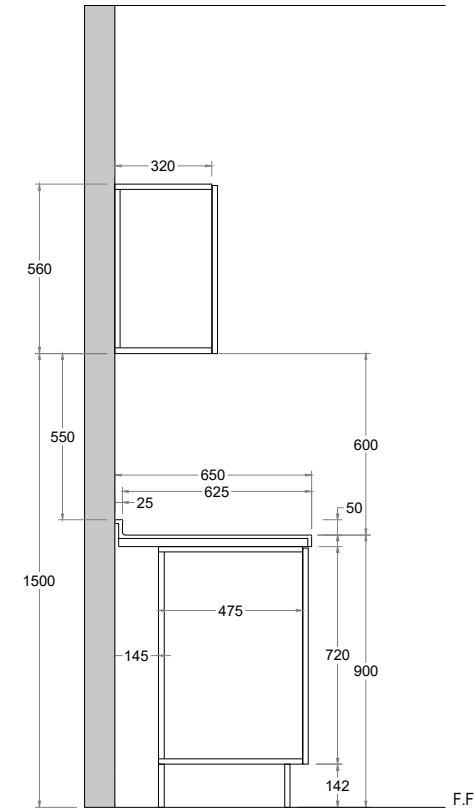
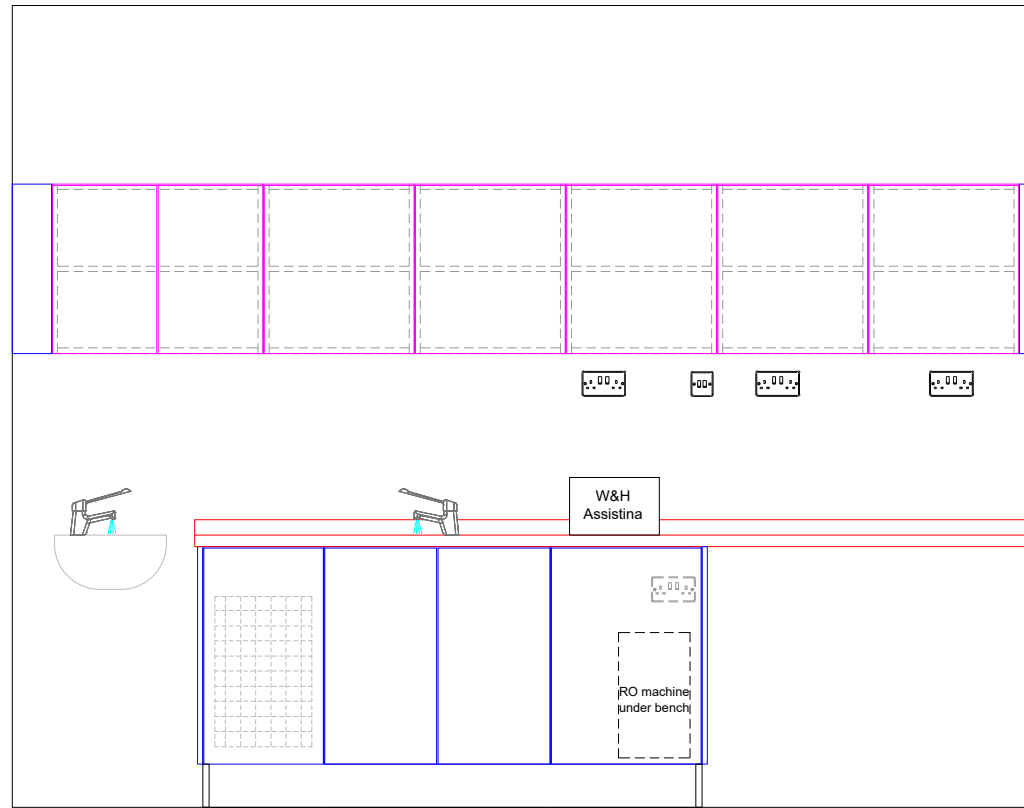

Cabinetry Section

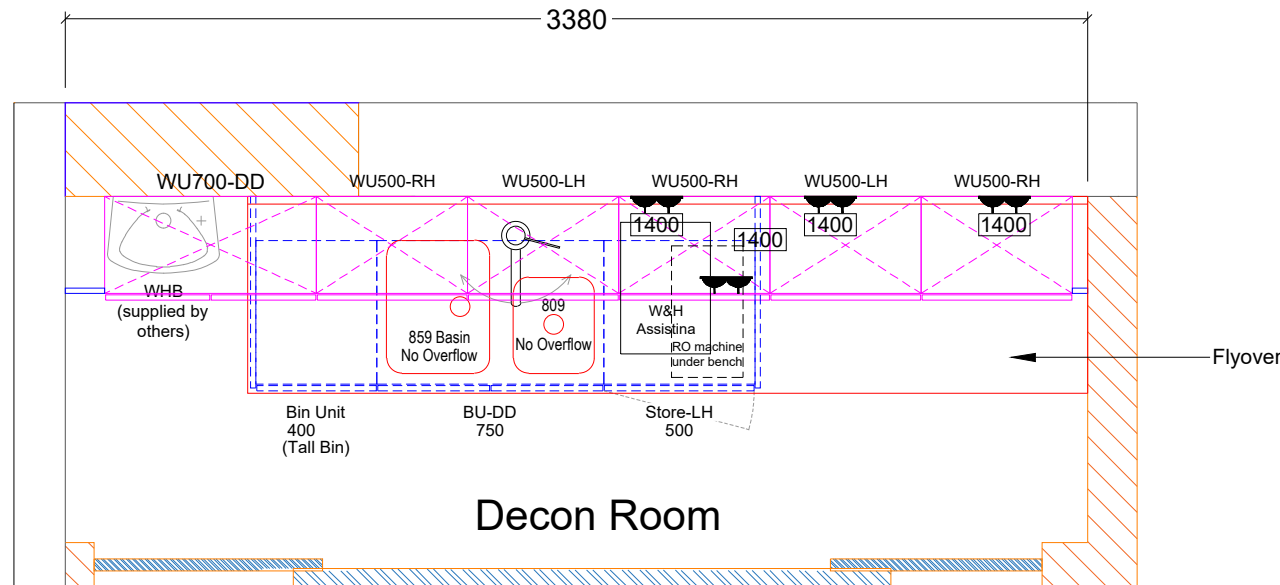

Decon Room

NOTE:
Handles are removed for clarity and will be fitted unless handle free has been quoted

IMPORTANT NOTES

WORK TO FIGURED DIMENSIONS ONLY.
CHECK DIMENSIONS ON SITE BEFORE COMMENCING WORK.

ANY DISCREPANCIES SHOULD BE REPORTED BACK TO OUR OFFICE.

X-RAY LOCATION / RPA

Any indications given in respect of radiation protection, the siting of x-ray equipment and / or x-ray controls is for guidance purposes only. It is for your appointed RPA to review the environment in which the x-ray machine is to operate and to ensure your compliance under IRR99. This drawing should not be used as the basis for any design, construction work or the provisioning of services involving x-ray equipment without the approval of your RPA.

THIS DESIGN SHOULD BE APPROVED BY YOUR INFECTION CONTROL ADVISOR PRIOR TO COMMENCEMENT OF WORKS.



Park Farm Lane, Nuthampstead
Herts SG8 8LZ

Tel: 01763 849990
Email: info@angliandental.co.uk

CLIENT: HIRSCHOWITZ

LOCATION: EDGE DENTAL CARE
150 BROADFIELDS AVENUE,
EDGWARE, MIDDLESEX
HA8 8SS

JOB: FIT-OUT

ROOM: DECON

JOB REF: 041929

DRAWING No: D40157	Rev
	D

DRAWING SCALE: 1:25	A3
---------------------	----

	NAME	DATE
DRAWN BY:	GH	25/07/2022
CHECKED BY:	*	*

DO NOT SCALE FROM THIS DRAWING.

ALL DIMENSIONS ARE IN mm UNLESS OTHERWISE STATED

THIS DRAWING IS AN ANGLIAN DENTAL ENGINEERING A3 ORIGINAL

COPYRIGHT ANGLIAN DENTAL ENGINEERING ©2022